

state what the angles are indicated by a letter, giving reasons for your answer

(1)

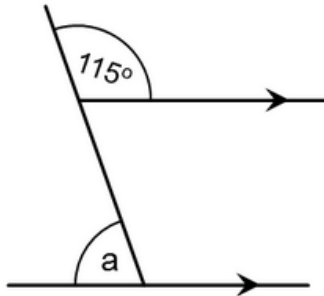

(2)

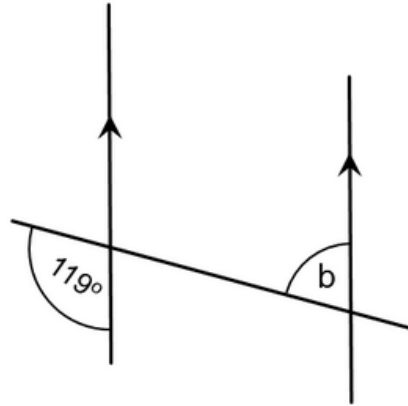

(3)

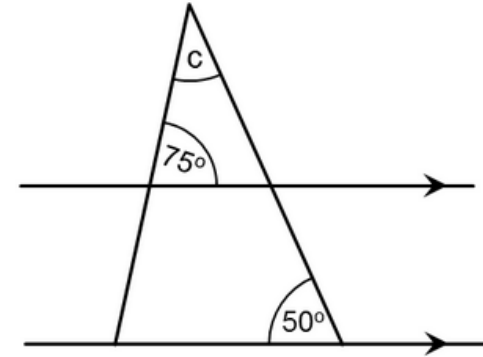

(4)

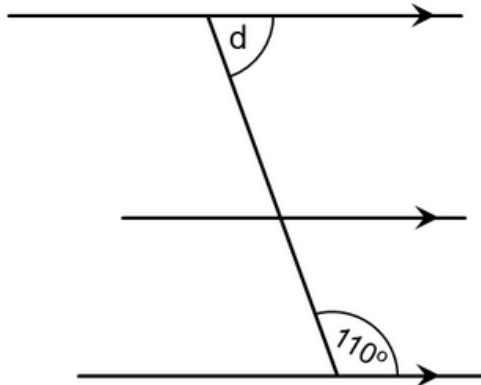

(5)

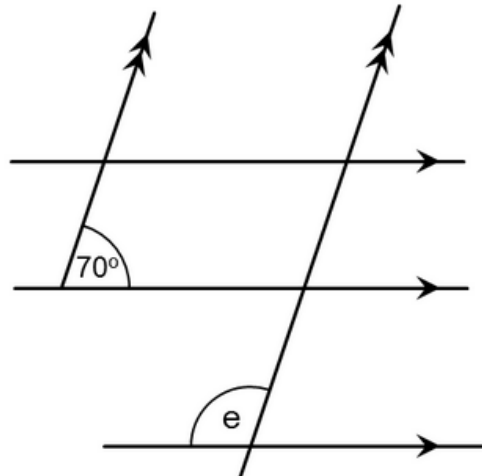

(6)

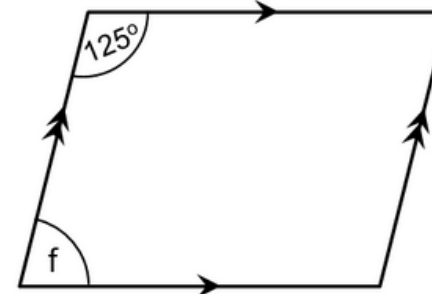

state what the angles are indicated by a letter, giving reasons for your answer

(7)

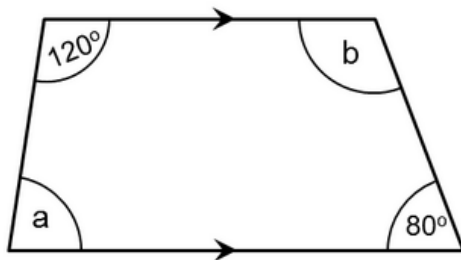

(8)

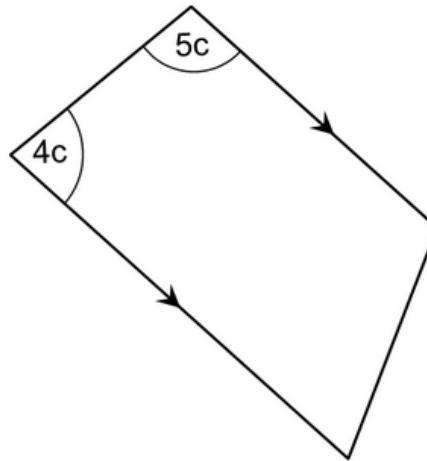

(9)

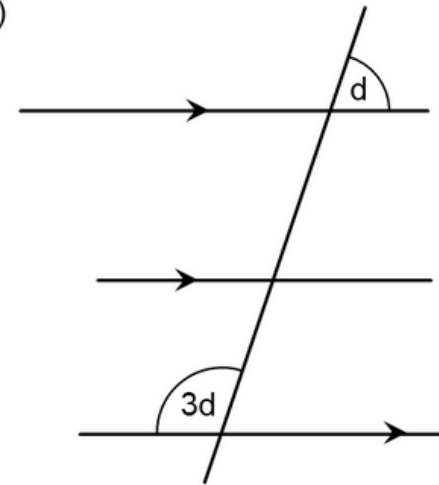

(10)

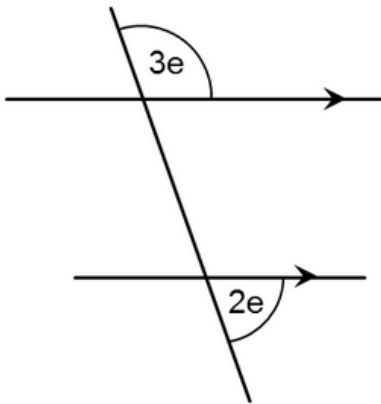

(11)

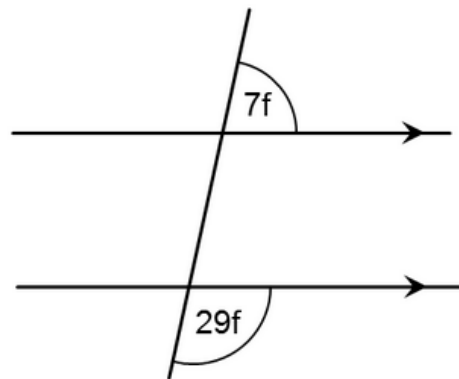

(12)

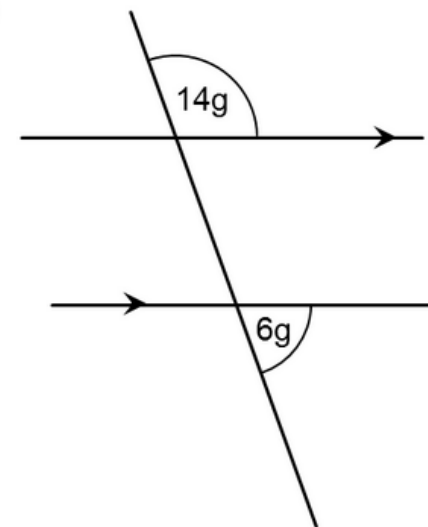

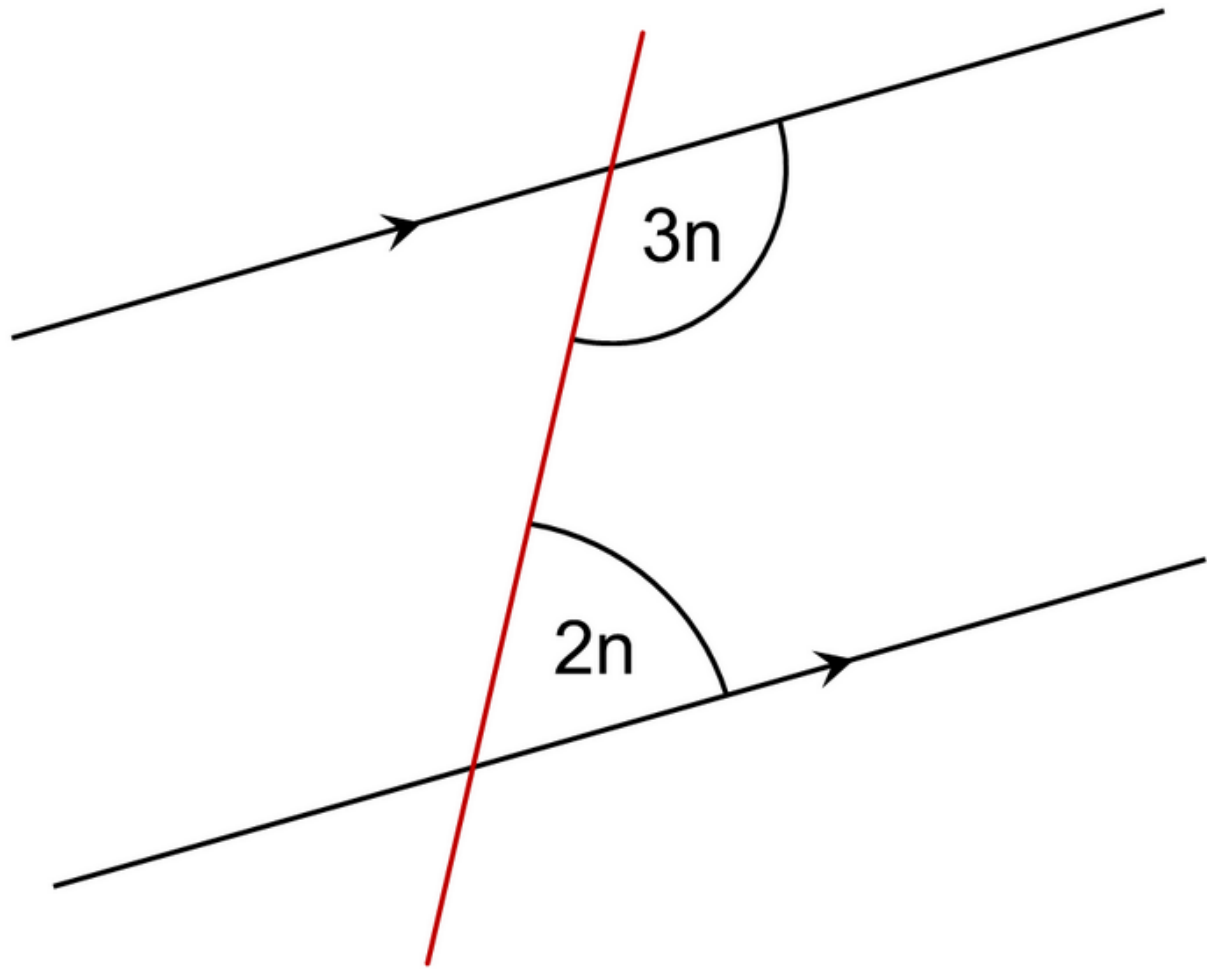

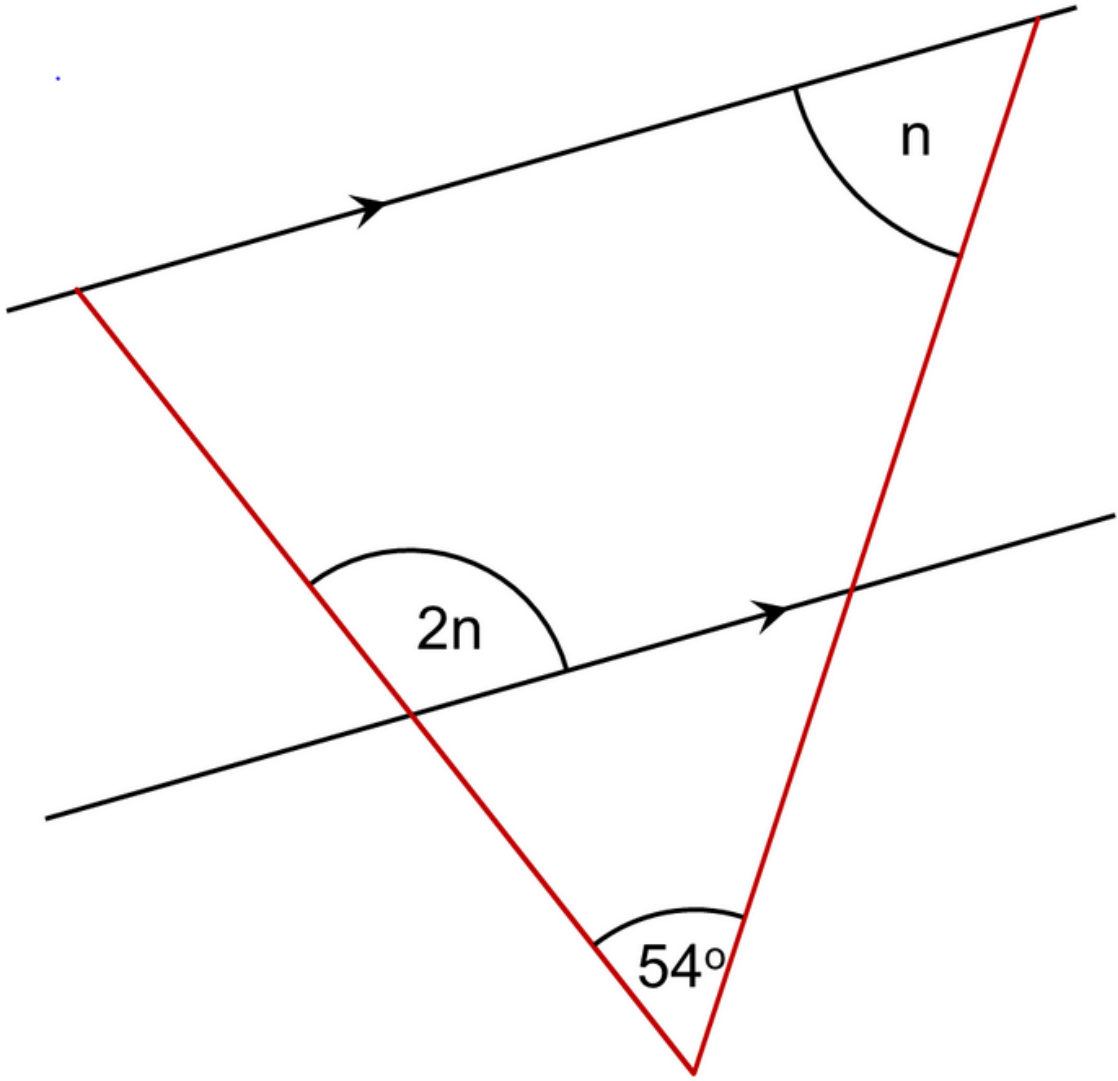

state what the angles are indicated by a letter, giving reasons for your answer

(1)

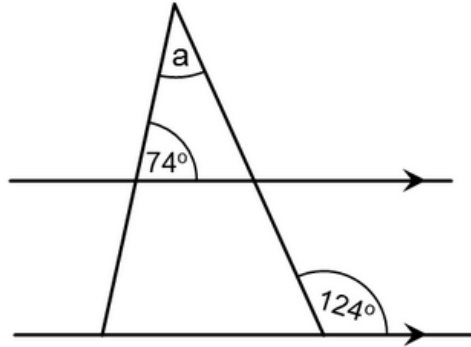

(2)

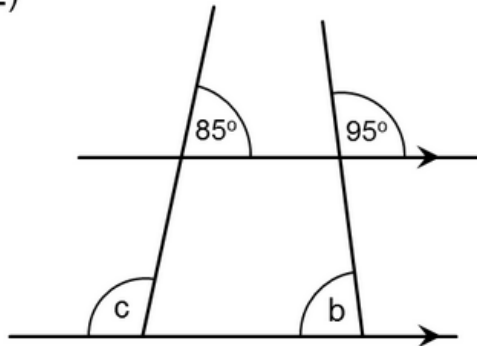

(3)

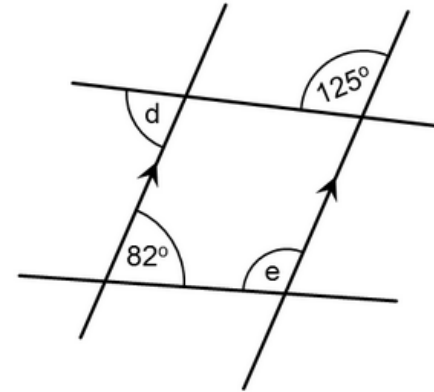

(4)

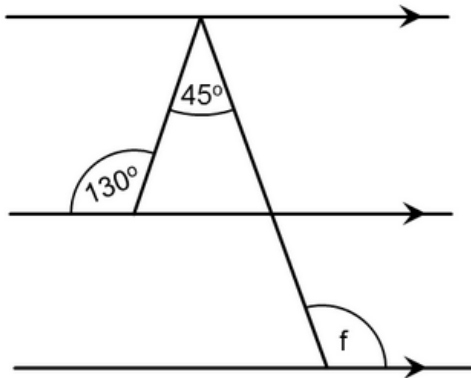

(5)

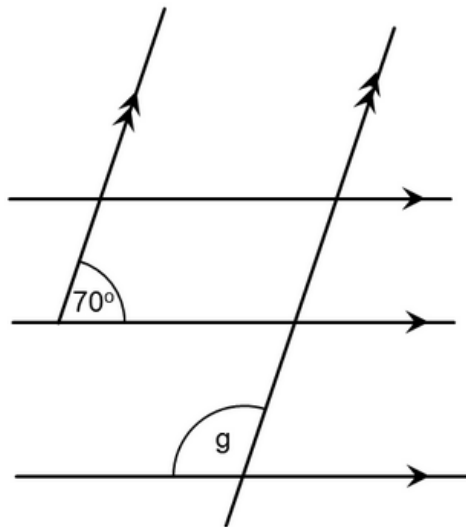

(6)

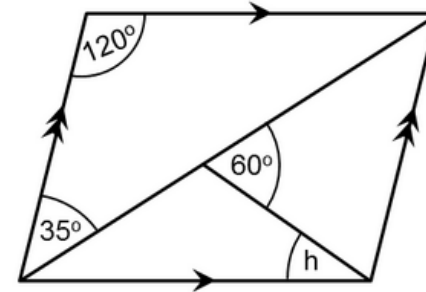

state what the angles are indicated by a letter, giving reasons for your answer

(7)

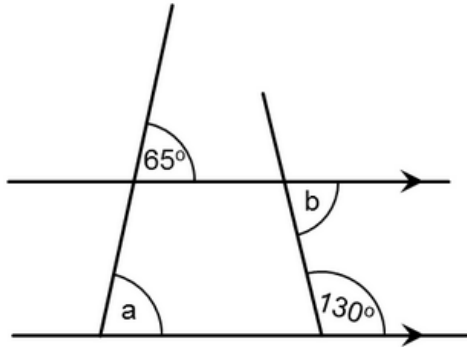

(8)

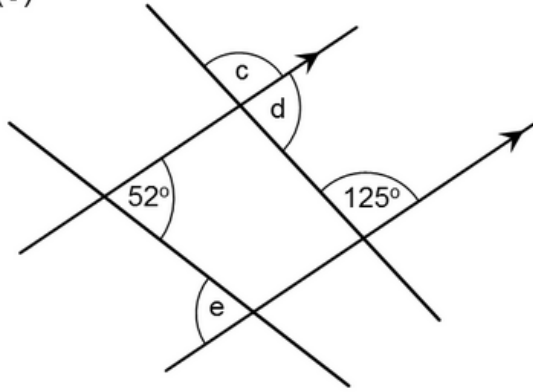

(9)

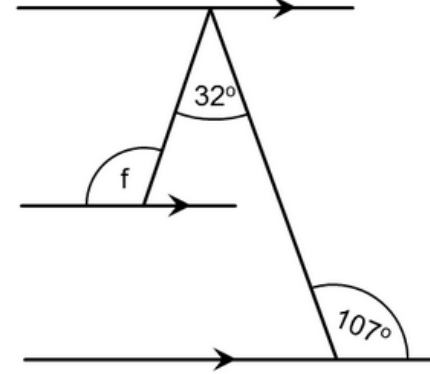

(10)

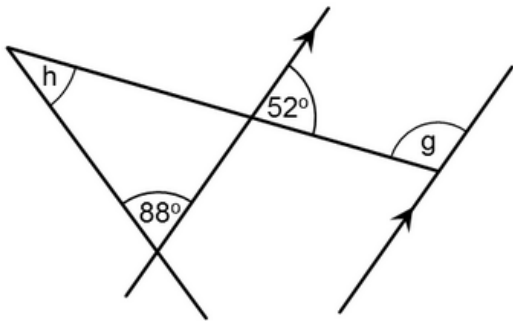

(11)

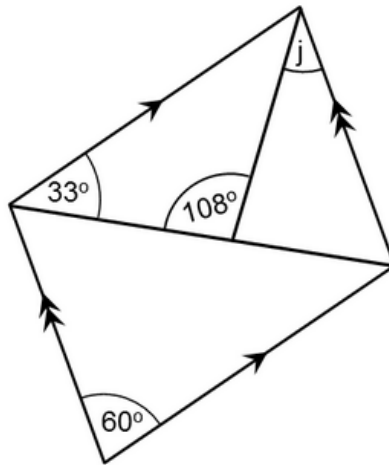

(12)

